

**CODE NUMBER**

3912747

**DESCRIPTION**

0.25 gpf, Polished Chrome Finish, Single Flush, Battery, Royal® Exposed Sensor Urinal Flushometer.

**DETAILS**

- Flush Volume: 0.25 gpf (0.9 Lpf)
- Finish: Polished Chrome (CP)
- Power Type: Battery
- Valve: Diaphragm
- Valve Body Material: Semi-red Brass
- Fixture Type: Urinal
- Fixture Connection: Top spud
- Rough-In Dimension: 11 ½" (292mm)
- Spud Coupling: ¾" (19mm)
- Supply Pipe: ¾" (19mm)

**FEATURES**

- True Mechanical Override Flush Button
- Four (4) size C alkaline batteries included
- "Low Battery" Flashing LED
- "User in View" Flashing LED
- 72-Hour Sentinel Flush
- ¾" I.P.S. screwdriver Bak-Chek® angle stop with free spinning, vandal resistant stop cap
- Sweat Solder Adapter w/Cover Tube and Cast Wall Flange with Set Screw
- No External Volume Adjustment to Ensure Water Conservation
- Handle Packing, Main Seat, Stop Seat and Vacuum Breaker Molded from PERMEX® Rubber Compound for Chloramine resistance
- Infrared Sensor with Multiple-focused, Lobular Sensing Fields for high and low target detection

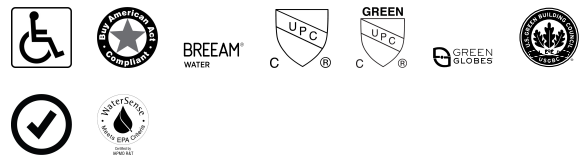
**COMPLIANCES & CERTIFICATIONS**

(ADA Compliant, BAA Compliant, BREEAM Water Credit, cUPC Certified, cUPC Green Certified, Green Globes Water Credit, LEED V4 Water Efficiency Credit, Satisfies LEED Credits, WaterSense Listed)

**RECOMMENDED SPECIFICATION**

Valve Body, Cover, Tailpiece and Control Stop shall be in conformance with ASTM Alloy Classification for Semi- Red Brass. Valve shall be in compliance with the applicable sections of ASSE 1037 and ANSI/ASME 112.19.2.

**VALVE OPERATING PRESSURE (FLOWING)**

15–80 PSI (103–552 kPa). Specific fixtures may require greater minimum flowing pressure - consult manufacturer requirements.

**DOWNLOADS**

- [EBV-500/550-A Installation Instructions](#)
- [Control Stop Repair and Maintenance Guide](#)
- [Flush Connections Flanges Repair and Maintenance Guide](#)
- [Tail Piece Repair and Maintenance Guide](#)
- [Additional Downloads](#)

**NOTES**

All information contained within this document subject to change without notice.

Looking for other variations of the ROYAL 186 SFSM product? [View the general spec sheet with all options.](#)

[Find a compatible urinal](#) for this flushometer.

[Find a compatible water closet](#) for this flushometer.

Watersense compliant when used with a WaterSense compliant fixture

**Sloan 10500 Seymour Ave, Franklin Park, IL 60131**

Phone: 800.982.5839 • Fax: 800.447.8329 • [sloan.com](http://sloan.com)

**ROUGH-IN**

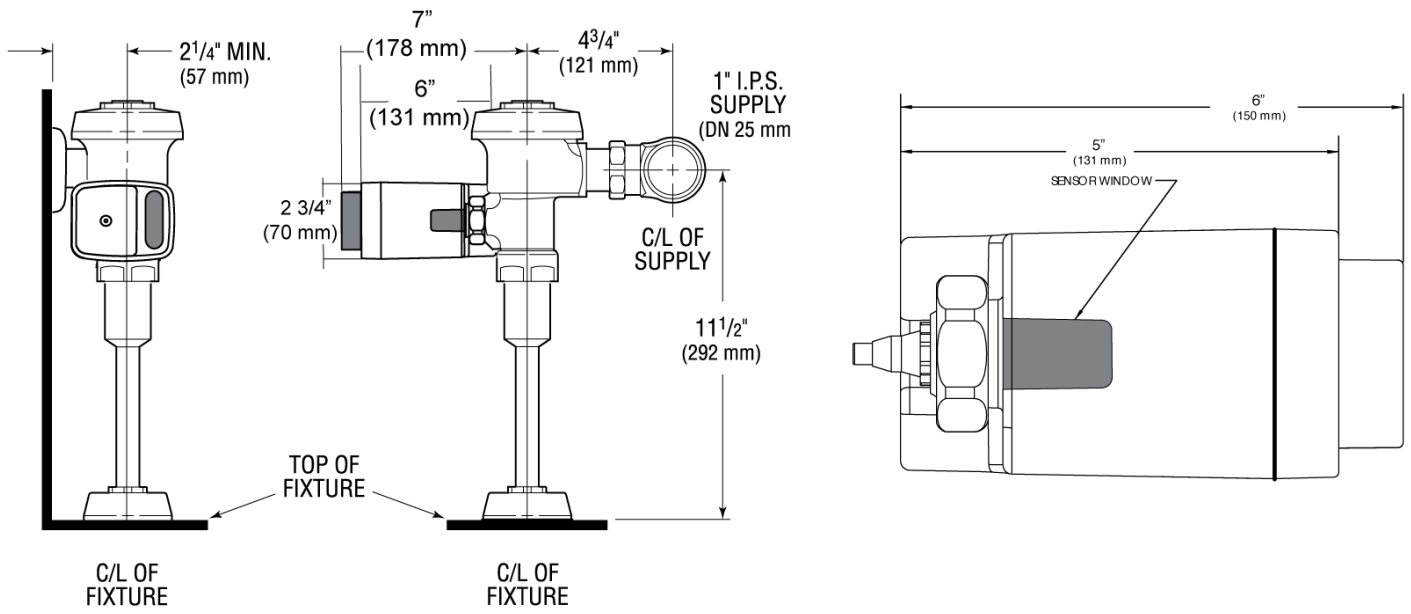

Sloan 10500 Seymour Ave, Franklin Park, IL 60131

Phone: 800.982.5839 • Fax: 800.447.8329 • [sloan.com](http://sloan.com)