

BRIZO®

COLD WATER DISPENSERS

- Single Handle Deck Mount
- 1 Hole Sink Applications
- Integrated Supply Tubes
- Air Gap Included

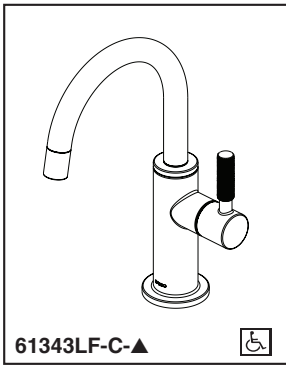

61343LF-C-▲



Submitted Model No.: _____

Specific Features: _____

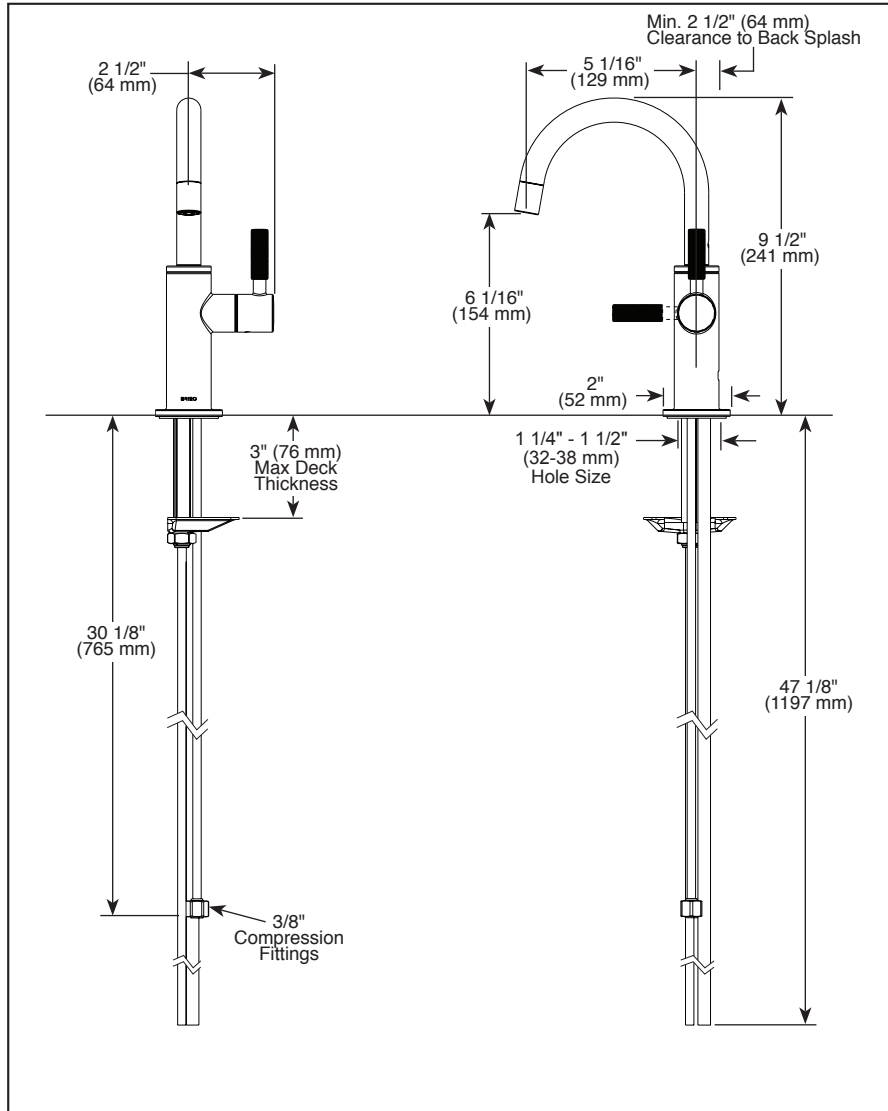

▲ Designate proper finish suffix

FEATURES:

- Diamond Seal® Technology

STANDARD SPECIFICATIONS:

- Laminar water stream with max flow rate 1.5 gpm @ 60 psi, 5.7 L/min @ 414 kPa
- Works with RO systems, filtered water systems, or as a cold water tap
- Spout swings 360°
- Single lever handle design
- Air gap included with 1/4" tube for RO system and 3/8" tube for drain
- Mounting wrench to assist in tightening mounting nut securely
- Integrated supply tube with 3/8" compression fitting

WARRANTY

- Parts and Finish - Lifetime limited warranty; or for commercial purchasers, 10 years for multi-family residential (apartments and condominiums) and 5 years for all other commercial uses, in each case from the date of purchase.
- Electronic Parts and Batteries (if applicable) - 5 years from the date of purchase; or for commercial purchasers, 1 year from the date of purchase. No warranty is provided on batteries.

COMPLIES WITH:

- ASME A112.18.1 / CSA B125.1
- ASME A112.18.6
-  Indicates compliance to ICC/ANSI A17.1
- Verified compliant with .25% weighted average Pb content regulations.