

RESORT CORNER PEDESTAL LAVATORY

Cat. No.
3-1091



Faucet not included

W: 17-3/4"
D: 15-3/4"
H: 31-3/8"
Sides: 7"

Column Dimensions

Column: 5-1/2" X 5"

Interior Dimensions:

Basin interior:	14 1/2" X 7 3/4"
Basin depth:	5"
Mount bolts height:	28-1/4"
Mount holes cc:	6"
Back of basin to center of faucet:	4-1/4"
Back of basin to center of drain:	8-3/4"
Faucet hole diameter:	1-3/8"

Features:

- ▶ Made of Vitreous China
- ▶ Designed for corner installation
- ▶ Available with 1 faucet hole
- ▶ Pre-drilled overflow hole
- ▶ Back of column is open
- ▶ Mounting Hardware Included
- ▶ For ease installation order Hangers (pair) or Bracket (one)



Colors:
WH White

Compliance Certification
Meets or exceeds the following specifications: ASME A112.19.2 2018 and CSA B45.1-18 for plumbing fixtures.

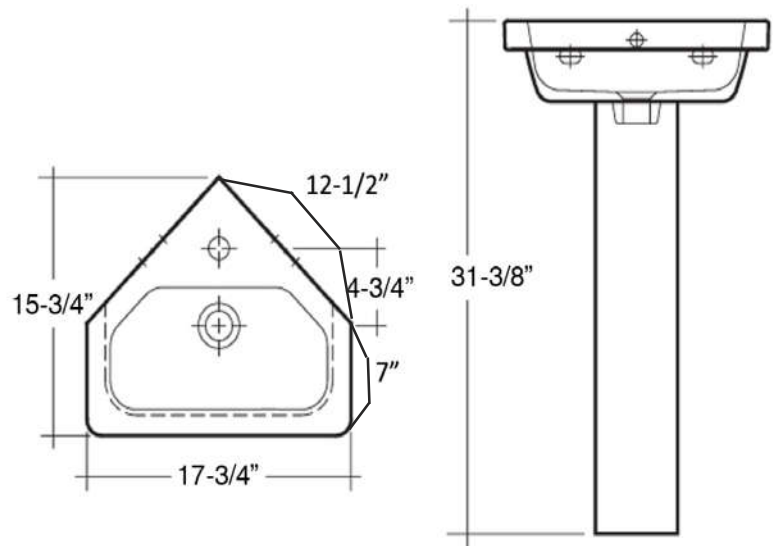

Dimensions of fixture are nominal and may vary within the range of tolerances established by ASME Standard A112.19.2-2018. Dimensions and specifications subject to change without notice.