

**RADCLIFF
67" ACRYLIC
OVAL TUB**

Cat. No.
ATSOVN67F



L: 66-1/2"
W: 29-1/2"
H: 23-1/2"

Rim: 1-1/2" W
Water depth: 17-3/8" to top of tub
Water depth: 12-7/8" to overflow

The following is recommended for ATSOVN67F tubs:

- Faucets: part #7901 or 7913
- Leg tub drain: part #5599LT or 5599TS



Overflow can be drilled. With overflow drilled this tub requires drain 5599PD. **Tubs that have been drilled with overflow are "special order" and are not returnable.**

Gallon Capacity without OF:	55
Gallon Capacity with OF:	46
Shipping Weight:	175 lbs.
Empty Weight:	115 lbs.
Filled Weight without OF:	548 lbs.
Filled Weight with OF:	472 lbs.

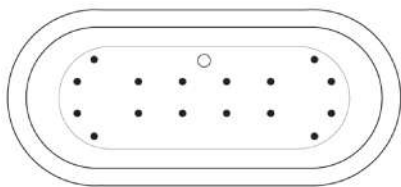

(Air jet configuration if system is added, more info on page 2.)

Features:

- ▶ Interior and exterior walls acrylic sheets
- ▶ Air between sheets provides insulation to retain warmth
- ▶ For use with a freestanding tub filler or faucet mounted on the wall
- ▶ No faucet holes
- ▶ No overflow
- ▶ Tub is thoroughly inspected before shipment
- ▶ IAPMO Certified
- ▶ Option to add foam insulation between tub walls available
- ▶ **New:** Air jet system now available, more info on page 2



Custom Colors Available (inside of tub is always white enamel):
Painted bathtubs are considered "special order" and are not returnable
\$160 Bisque or Black \$250 Designer Color

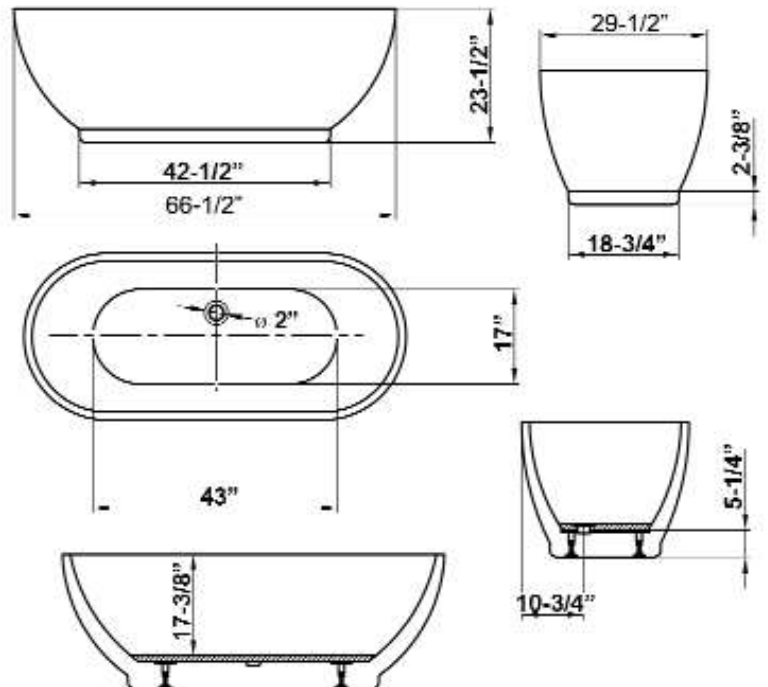

Dimensions of fixture are nominal and specifications subject to change without notice.

BATHTUB AIR JET KIT

Cat. No.
AIR KIT 1, AIR KIT 2

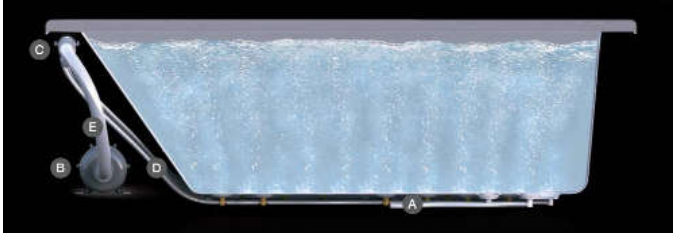

- A** AIR JET - Bottom air jets for maximum bubble action.
- B** BLOWER - The heart of the massage system.
- C** MANIFOLD - Double back flow security prevention device.
- D** FLEXIBLE PVC HOISING - IAPMO certified.
- E** MAIN AIR INTAKE HOSE - High temperature and pressure resistant.

Features:

- ▶ 750 Watt blower motor operates system
- ▶ 300 Watt air heater warms air
- ▶ System powered by 120V
- ▶ 16 brass air jets placed in bottom of tub
- ▶ Each air jet has 24 holes
- ▶ Air jet caps available in white (AIR KIT 1) or black (AIR KIT 2)
- ▶ Includes 1 1/4" x 3' main air hose plus 1 1/4" x 9' extension hose
- ▶ Automatic system purge after each use
- ▶ Automatic safety timer turns off system after 20 minutes
- ▶ Includes water tight remote control
- ▶ Compatible with most acrylic, copper and resin tubs with no feet
- ▶ Not available with cast iron tubs or tubs with feet

Air Kit is installed in tub before shipment

INSIDE TUB VIEW - WILL VARY BY TUB DESIGN



Air Jet



Remote

Oval bathtub
Sample jet configuration

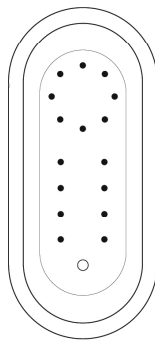

with end drain

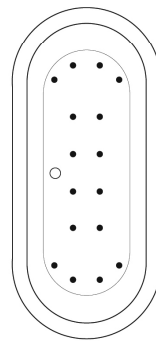

with center drain

Rectangular bathtub
Sample jet configuration

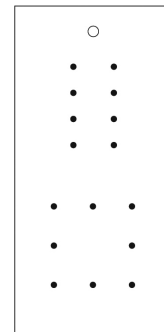

with end drain

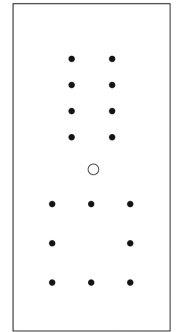

with center drain

Round bathtub
Sample jet configuration

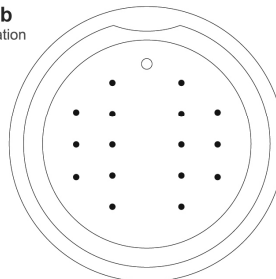

These diagrams are general representations.
Jet placement may vary dependent on tub shape

Features:

(16) Maxi Air Jets



Elbows for air jets



Tees for air jets